

Y32xx Model

9X14 mm SMD, 5V, HCMOS/TTL

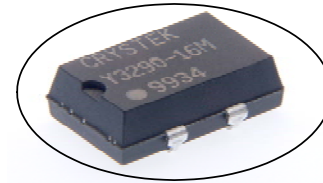

Clock Oscillator



Frequency Range: 1.544MHz to 66.667MHz
Frequency Stability: ±50ppm to ±100ppm
Temperature Range:
 Operating: 0°C to 70°C
 (Option M) -20°C to 70°C
 (Option E) -40°C to 85°C
Storage: -55°C to 120°C
Input Voltage: 5V ± 0.5V
Input Current: 35mA Max @ 66MHZ
Output: HCMOS/TTL
 Symmetry: 40/60% Max @ 50% Vdd
 Rise/Fall Time: 8ns Max @ 20% to 80% Vdd
 Logic: "0" = 10% Vdd Max
 "1" = 90% Vdd Min
 Load: 50pF/10TTL Max
Jitter RMS: 12KHz~20MHz 0.5ps Typ, 1ps Max
Aging: <3ppm 1st/yr, 1ppm every year thereafter

Designed to meet today's requirements for low jitter 5V applications. The Y32xx Series is a Non-PLL based oscillator design for excellent jitter performance. Available on tape and reel in quantities of 1K.

Dimensions inches (mm)
 All dimensions are Max unless otherwise specified.

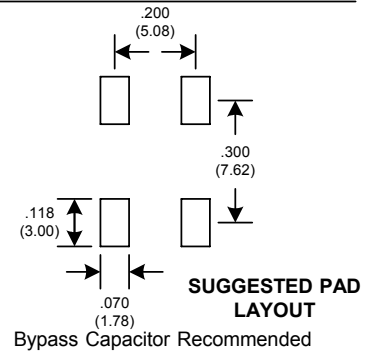
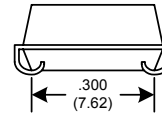
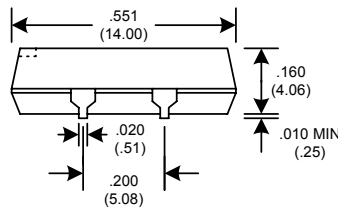
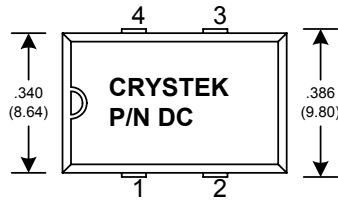

RECOMMENDED REFLOW SOLDERING PROFILE

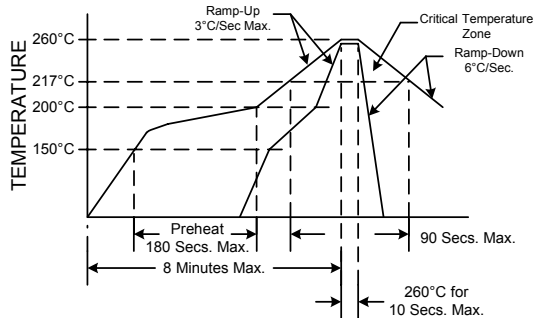

NOTE: Reflow Profile with 240°C peak also acceptable.

Tri-State Function	
Function pin 1	Output pin
Open	Active
"1" level 2.4V Min	Active
"0" level 0.4V Max	High Z

Crystek Part Number Guide

Example: Y3292-44.736MHZ
 Intermediate Temp: YM3292-44.736MHZ
 Extended Temp: YE3292-44.736MHZ
 Y = 0°C to 70°C
 *YM = -20°C to 70°C, *YE = -40°C to 85°C

Symmetry 40/60%	
Part Number	Freq. Stability
Y*3290	+/- 100ppm
Y*3292	+/- 50ppm
	(+/- 100ppm only) -40°C to 85°C

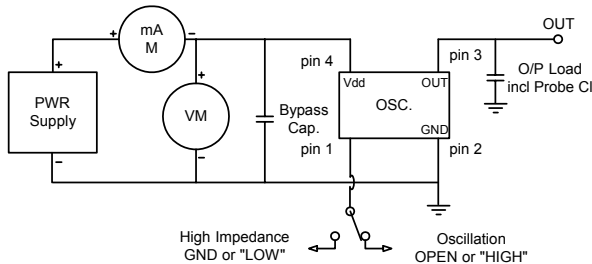

Specifications subject to change without notice.

TD-0240501Rev.B

